

Assembly instructions for a table with legs

Principe d'assemblage d'une table à pattes

Procedimiento de ensamblaje de una mesa con patas



Do not climb on the table.
Risk of serious injuries.
Ne pas monter sur la table.
Risque de blessures graves.
No treparse sobre la mesa.
Riesgo de herirse gravemente.

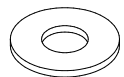

a 4 x



b 4 x



c 4 x

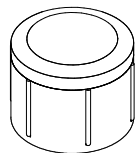

d 2 x

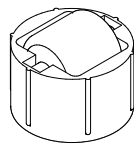

e 2 x

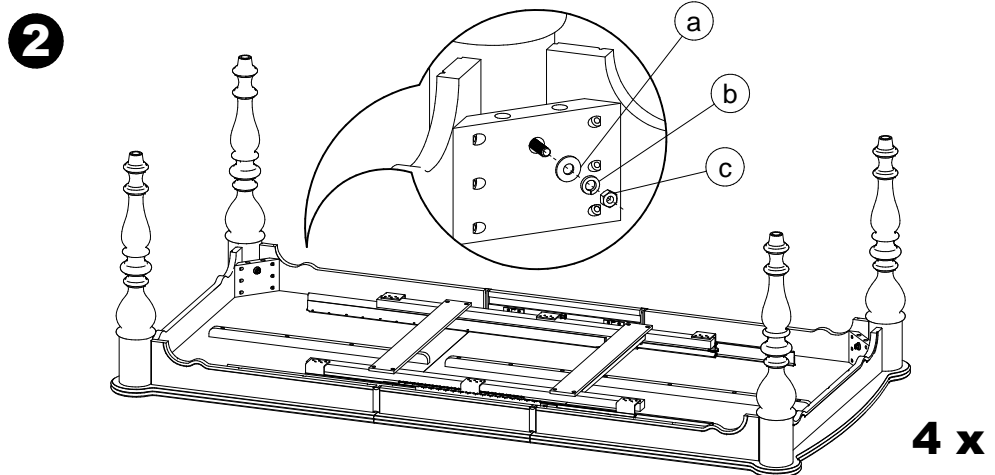
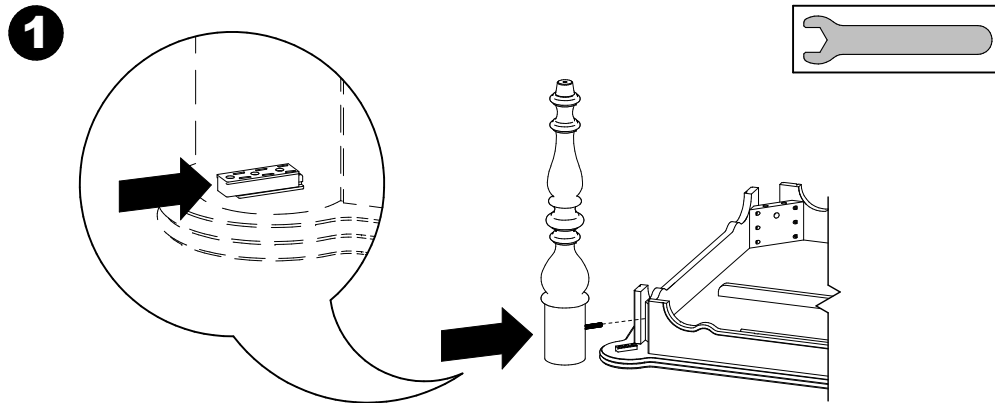

3

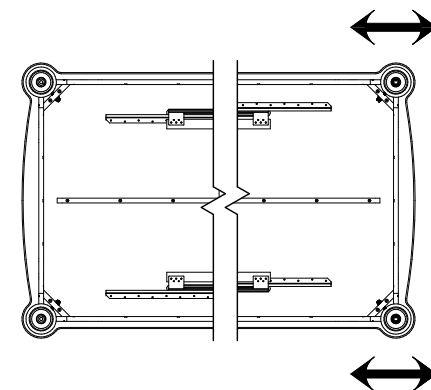
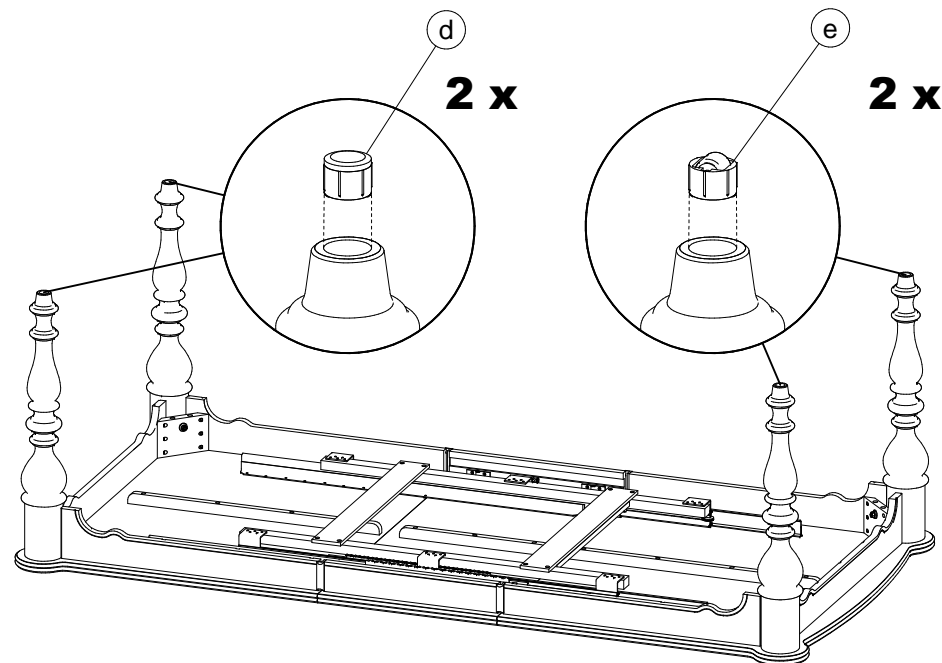

Pay attention to the direction of rotation.
Respecter le sens de rotation.
Respetar el sentido de rotación.

Informations internes seulement - NE PAS INCLURE CETTE PAGE DANS LE SAC

CODE PRODUIT SAC:	QUI2SACZ086		
CODE PRODUIT INFO-CLIENT:	FOP2INZTAB-1086 (À INCLURE DANS LE SAC)		
REVISION:	P01		
NO	DESCRIPTION	NOM	QTÉ
1	LOCK WASHER 5/16 ZINC	FOAVISZLW 5-16	4
2	ECROU 5/16-18 ZINC	FOAVISZHN5-16-18	4
3	WASHER 5/16 (STD) ZINC	FOAVISZWAS3-8H 5-16B	4
4	ANTI-DÉRAPANT PÖTTKER ENCASTRÉE Ø25 X16mm N°:16100	QUIACZSPATTE16100	2
5	ROULETTE PÖTTKER ENCASTRÉE Ø25 X16mm N°:16086	QUIACZROULETTE16086	2

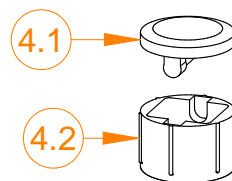
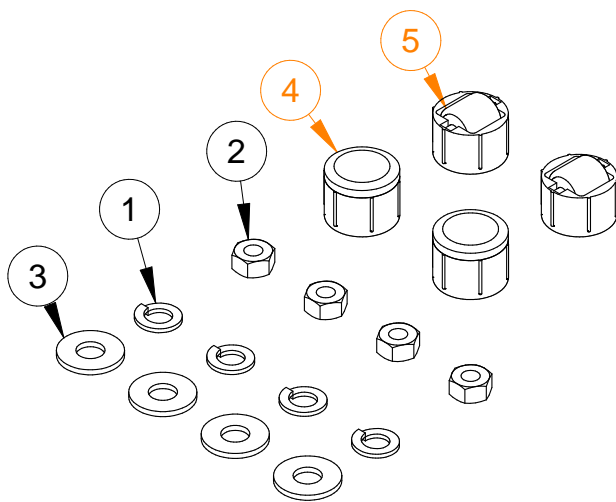

SOUS-COMPOSANTES QUIACZSPATTE16100		
NO	DESCRIPTION	QTÉ
4.1	ANTIDÉRAPANT	2
4.2	CAISSON	2

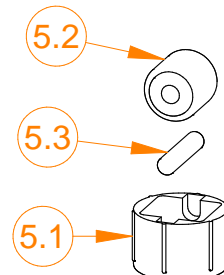

SOUS-COMPOSANTES QUIACZROULETTE16086		
NO	DESCRIPTION	QTÉ
5.1	CAISSON	2
5.2	ROULETTE	2
5.3	TIGE	2

**** PARTICULARITÉ POUR CES ENSEMBLES:**

**VOUS DEVEZ COMMANDER L'ENSEMBLE QUI ARRIVE EN SOUS-COMPOSANTES.
LES PRÉ-ASSEMBLER ET LES METTRE DANS LE SAC SELON LES QUANTITÉS
DEMANDÉES PLUS HAUT.**