

Assembly instructions for double pedestal table

Principe d'assemblage d'une table à base double

Procedimiento de ensamblaje de una mesa con base doble

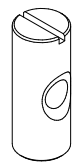

a 6 x

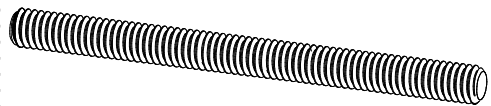

b 6 x

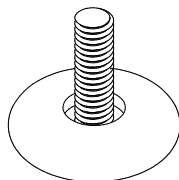

c 4 x

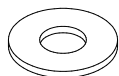

d 14 x



e 6 x



f 14 x

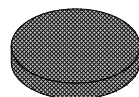

g 4 x

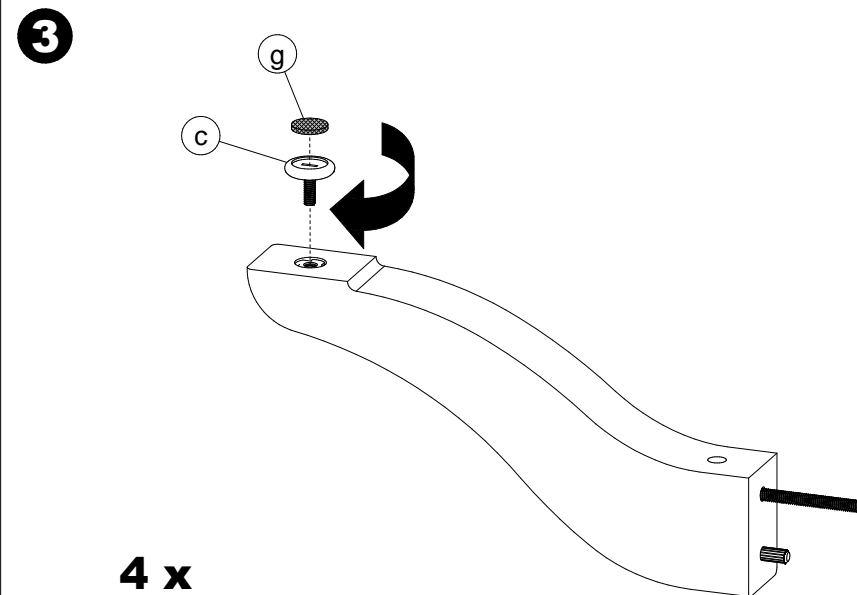
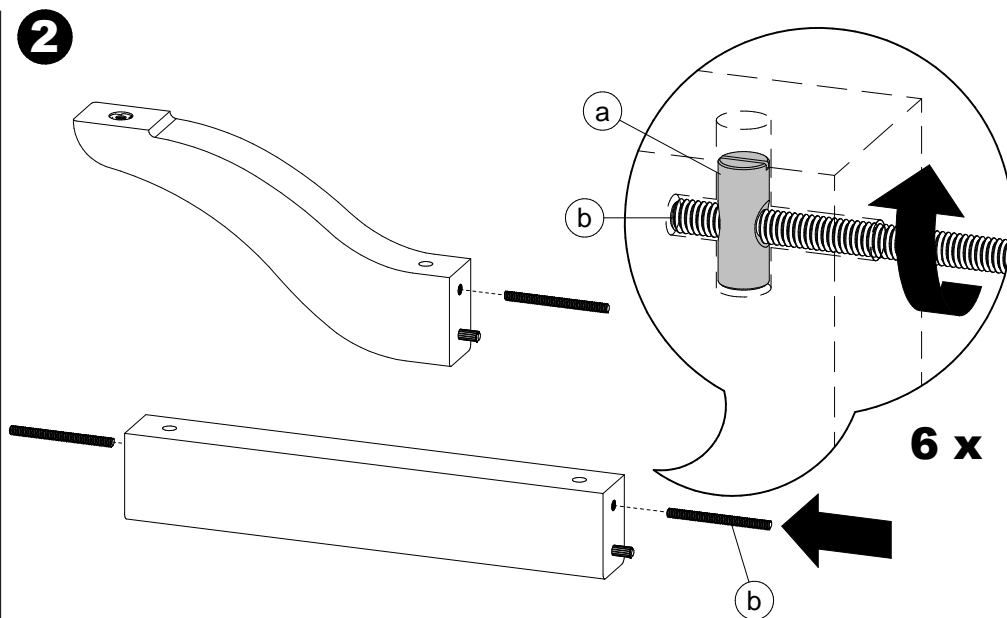
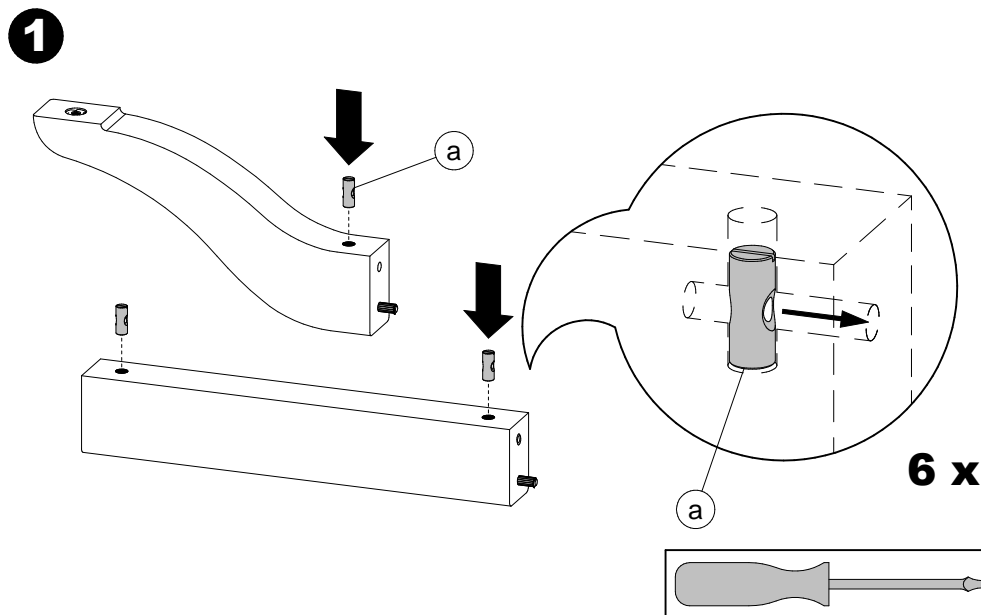

Assembly instructions for double pedestal table
Principe d'assemblage d'une table à base double
Procedimiento de ensamblaje de una mesa con base doble



Do not climb on the table.
 Risk of serious injuries.
Ne pas monter sur la table.
Risque de blessures graves.
 No treparse sobre la mesa.
 Riesgo de herirse gravemente.

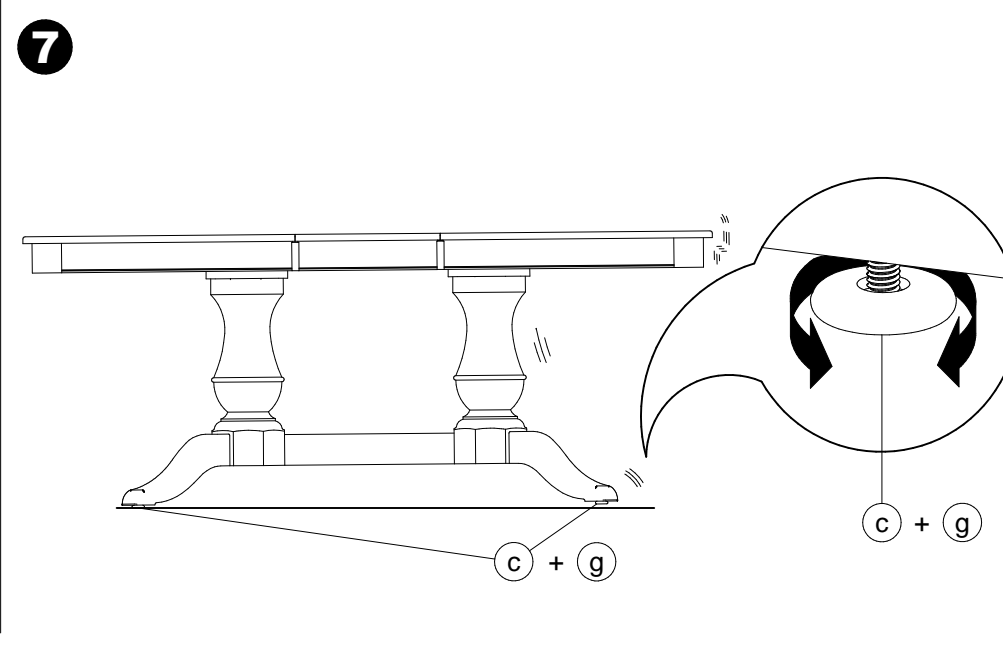
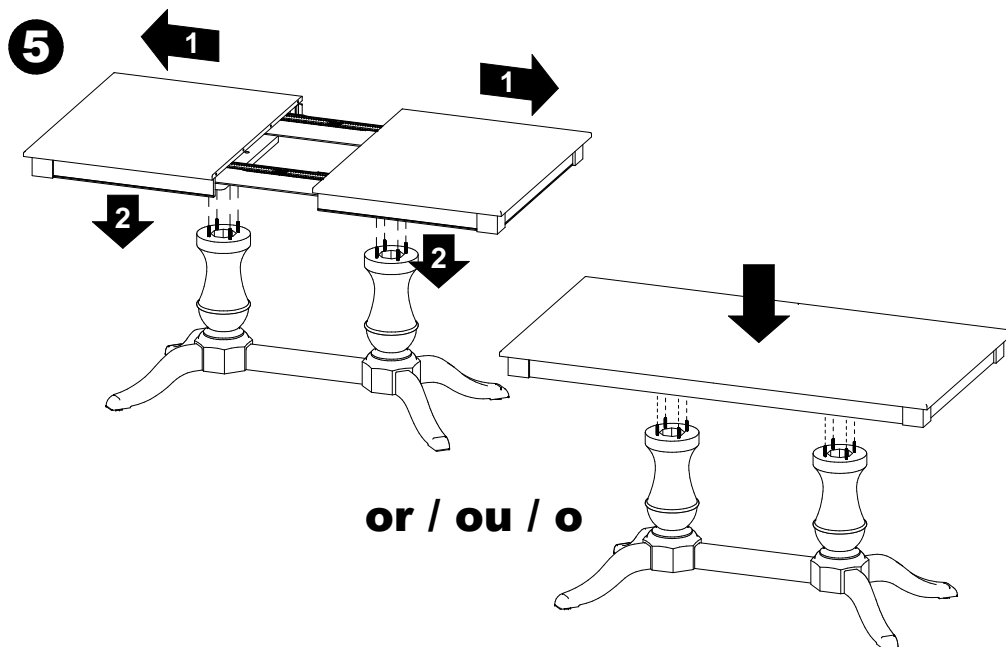
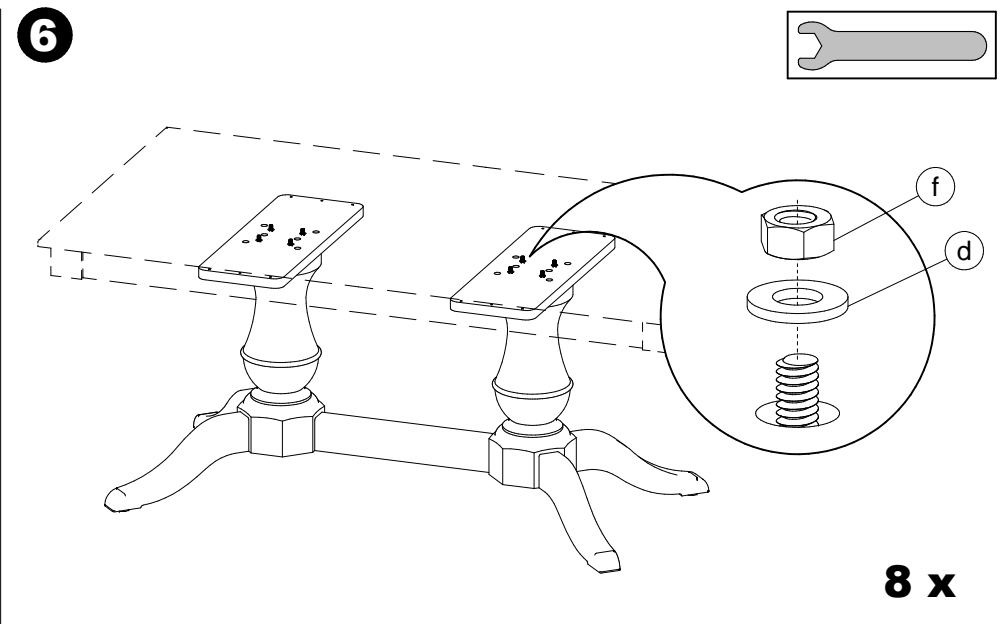
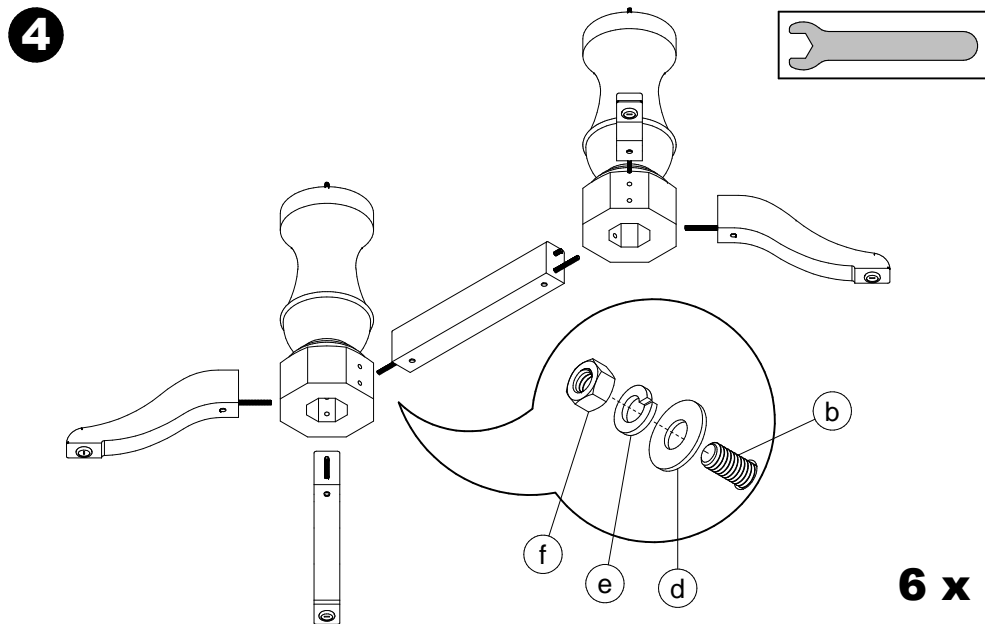

CODE PRODUIT SAC:	QUI2SACZ075	
CODE PRODUIT INFO-CLIENT:	FOP2INZTAB-1075	
REVISION:	P01	
DESCRIPTION	NOM	QTÉ
BARREL NUT 5/16-18 X 30MM	FOAVISZCD5-16-18X30MM	6
ECROU 5/16-18 ZINC	FOAVISZHN5-16-18	14
LOCK WASHER 5/16 ZINC	FOAVISZLW 5-16	6
TIGE FILETÉE 5/16-18 X 4 3/4"	FOAVISZTF5-16-18X4 3-4	6
WASHER 5/16 (STD) ZINC	FOAVISZWAS3-8H 5-16B	14
NIVELEUR DIA1 3/8"; 5/16-18X7/8"	QUIACCZ00701C	4
FEUTRE COLLANT DIA. 1"	QUIACCZFEUTREV23125	4